

ACCESSORI



IF 99

Presa acqua cilindrica in ottone con supporto.
Completa di flessibile satilux e doccetta in ottone.
Round water supply with support.
With luxury flexible and shower.

Art. _____

IF 99

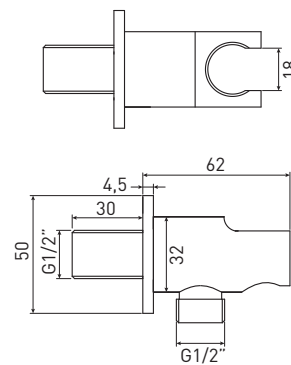

SA 99

Presa acqua cilindrica in ottone con supporto.
Completa di flessibile satilux e doccetta in ABS.
Round water supply with support.
With luxury flexible and shower.

Art. _____

SA 99

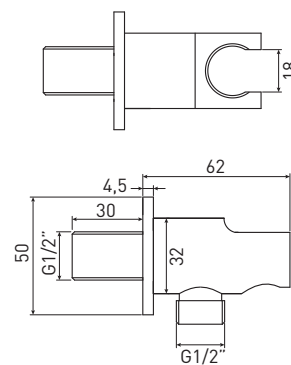

SY 99

Presa acqua quadrata in ottone con supporto.
Completa di flessibile satilux e doccetta in ottone.
Square water supply with support.
With luxury flexible and shower.

Art. _____

SY 99

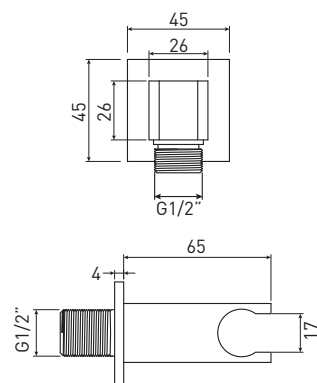

SH 99

Presa acqua quadrata in ottone con supporto.
Completa di flessibile satilux e doccetta in ABS.
Square water supply with support.
With luxury flexible and shower.

Art. _____

SH 99

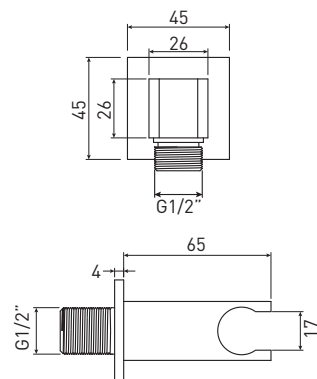

IF 98

Presca acqua cilindrica in ottone.
Round water supply.

Art. _____

IF 98

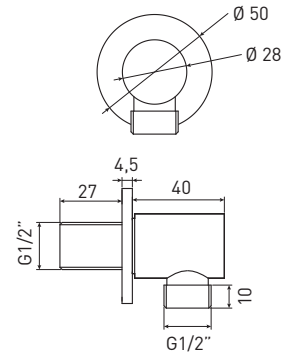

SH 98

Presca acqua quadrata in ottone.
Square water supply.

Art. _____

SH 98

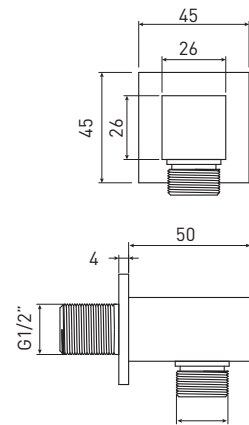

1410

Presca acqua in ottone.
Water supply.

Art. _____

1410

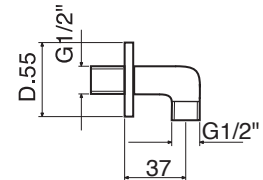

3910

Supporto inferiore in ottone per colonne con
attacco esterno U 3/4" - E 1/2".
Brass lower support for column, outlet
connection.

Art. _____

3910

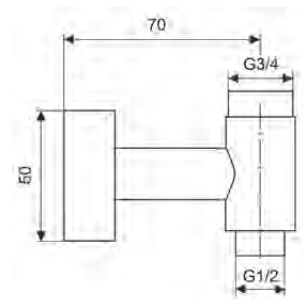

3920

Supporto inferiore in ottone per colonne con presa acqua incasso U 3/4" - E 1/2".
Brass lower support for column, inlet connection.

Art.

3920

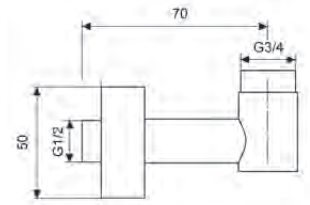

3930

Supporto inferiore in ottone per colonne con attacco esterno U 3/4" - E 1/2".
Brass lower support for column, outlet connection.

Art.

3930

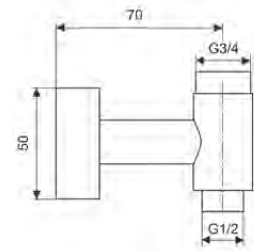
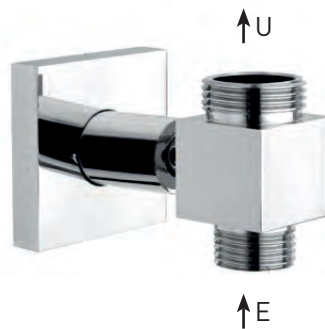

3940

Supporto inferiore in ottone per colonne con presa acqua incasso U 3/4" - E 1/2".
Brass lower support for column, inlet connection.

Art.

3940

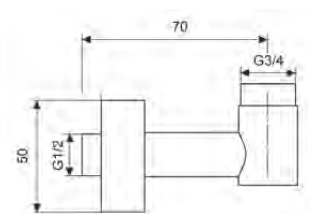
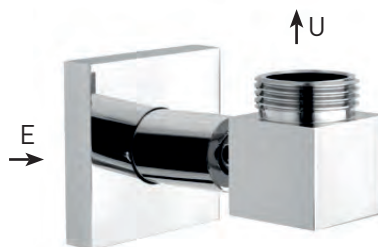

3950

Supporto inferiore in ottone per colonne con attacco esterno U 3/4" - E 1/2".
Brass lower support for column, outlet connection.

Art.

3950

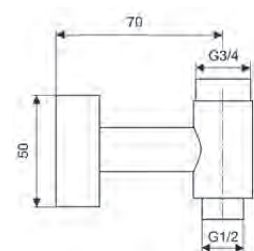
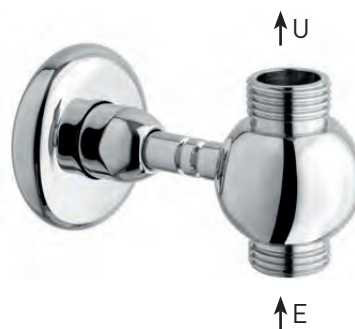

3960

Supporto inferiore in ottone per colonne con presa acqua incasso U 3/4" - E 1/2".
Brass lower support for column, inlet connection.

Art. _____
3960

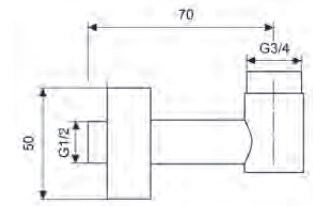

2081

Bocca a parete in ottone cromato.
Bath spout on the wall.
Wandauslauf.

Art. _____
2081

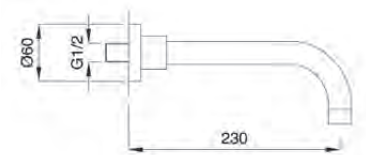

2082

Bocca a parete in ottone cromato.
Bath spout on the wall.
Wandauslauf.

Art. _____
2082

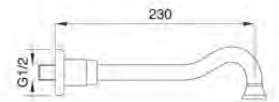

B15 - INOX

Bocca a cascata a parete attacco da 1/2".
S/S wall spout 1/2 M.

Art. _____
B15

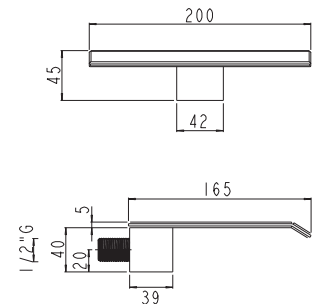

B09 - INOX

Bocca vasca chiusa a parete attacco 1/2".
Closed wall spout for bathtub set 1/2.

Art. _____

B09

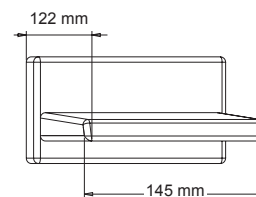

B10 - INOX

Bocca vasca aperta a parete attacco 1/2".
Opened wall spout for bathtub 1/2.

Art. _____

B10

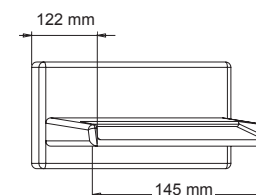

KI 9121

Set idroscopino in ottone cromato, flessibile
doppia aggraffatura cm. 120.
*Hydrobrush jet set, brass chrome plated tap,
flexible hose double lock cm. 120.*

Art. _____

KI 9121

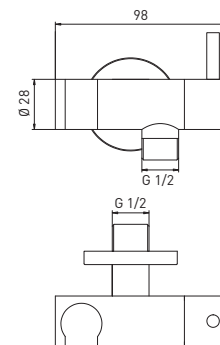

KI 9261

Set idroscopino in ottone cromato, flessibile
doppia aggraffatura cm. 120.
*Hydrobrush jet set, brass chrome plated tap,
flexible hose double lock cm. 120.*

Art. _____

KI 9261

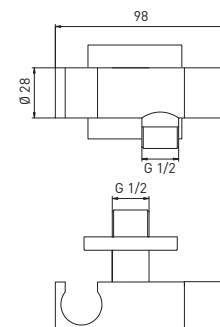

1285

Sifone da arredo in ottone quadro.
Brass syphon chrome.
Siphon.

Art. _____

1285

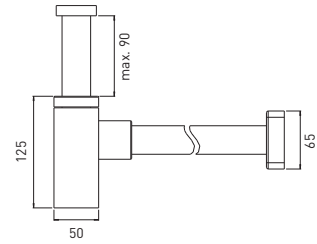

1290

Sifone da arredo in ottone tondo.
Brass syphon chrome.
Siphon.

Art. _____

1290

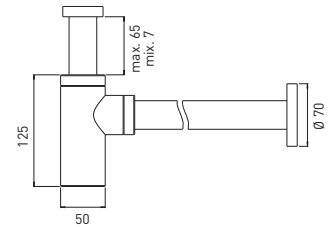

1103

Scarico Click Clack in ottone,
 regolabile con tappo tondo.
Click Clack pop up.
Click clack ablauf.

Art. _____

1103



1104

Scarico Click Clack in ottone,
 regolabile con tappo quadro.
Click Clack pop up.
Click clack ablauf.

Art. _____

1104



1815

Doccetta minimalista tonda in abs.

Abs round minimal shower.

Handbrause minimal.

Art.

1815

**1816**

Doccetta minimalista tonda in ottone.

Round minimal brass shower.

Handbrause minimal.

Art.

1816

**1830**

Doccetta minimalista quadra in abs.

Abs square minimal shower.

Handbrause minimal.

Art.

1830

**1831**

Doccetta minimalista quadra in ottone.

Square minimal brass shower.

Handbrause minimal.

Art.

1831



1820

Doccia antica in ottone.
Old fashion brass shower.
Handbrause antike.

1820

CR
BR - RA - NI
OR



1821

Doccia antica lusso in ottone.
Old fashion brass shower.
Handbrause antike.

1821

CR
BR - RA - NI
OR



1850

Doccia multigetto anticalcare in abs.
Abs multijet handshower with rubber clean.
Handbrause.

Art.

1850



1855

Doccia monogetto anticalcare in abs.
Abs monojet handshower with rubber clean.
Handbrause.

Art.

1855



1860

Doccia idromassaggio anticalcare multigetto abs.
*Multijets hydromassage abs handshower with
rubber clean.*
Handbrause mit Wasserstrahlmass.

Art.

1860

**1861**

Doccia idromassaggio anticalcare lusso
multigetto abs.
*Multijets hydromassage abs handshower with
rubber clean.*
Handbrause mit Wasserstrahlmass.

Art.

1861

**1900**

Doccia cucina 2 getti in abs.
Kitchen handshower 2 jets.
Handbrause.

Art.

1900

**1600**

Flessibile doccia Satilux.
Satilux flexible.
Flexibel.

Art. cm.

1600/150 150

1600/200 200



1620

Flessibile doccia doppia aggraffatura in ottone.
Double locked chromed flexible hose.
Flexibel doppelklammer.

1620/150 cm. 150

CR

BR - RA - NI

OR

1620/200 cm. 200

CR

BR - RA - NI

OR



1910

Flessibile cucina doppia aggraffatura in ottone con contrappeso.
Double locked chromed flexible hose, with counterweight.
Flexibel doppelklammer.

1910/150 cm. 150

CR

BR - RA - NI

OR

1910/200 cm. 200

CR

BR - RA - NI

OR



1000

Cartuccia ø 35 mm con distributore.
Ceramic cartridge ø 35 mm with distributor.
Kartusche ø 35 mm.

Art.

1000



1001

Cartuccia ø 35 mm senza distributore.
Ceramic cartridge ø 35 mm without distributor.
Kartusche ø 35 mm.

Art.

1001



1005

Cartuccia ø 40 mm con distributore.
Ceramic cartridge ø 40 mm with distributor.
Kartusche ø 40 mm.

Art. _____

1005

**1006**

Cartuccia ø 40 mm senza distributore.
Ceramic cartridge ø 40 mm without distributor.
Kartusche ø 40 mm.

Art. _____

1006

**1008**

Cartuccia ø 25 mm.
Ceramic cartridge ø 25 mm.
Kartusche ø 25 mm.

Art. _____

1008

**1009**

Cartuccia ø 30 mm.
Ceramic cartridge ø 30 mm.
Kartusche ø 30 mm.

Art. _____

1009

**1010**

Vitone ceramico.
Ceramic disk valve.
Oberteil aus keramik.

Art. _____

1010



1206

Rubinetto tondo sottolavabo in ottone
1/2M x 3/8M, senza filtro.
Brass round underbawash basin tap 1/2M x 3/8M.

Art. _____

1206



1207

Rubinetto quadrato sottolavabo in ottone
1/2M x 3/8M, senza filtro.
Brass squared underbawash basin tap 1/2M x 3/8M.

Art. _____

1207



AC 03

Dispositivo anticalcare 1/2".
Anti-limescale device 1/2".
Kalkschutz-orrichtung 1/2".

Art. _____

AC 03



AC 03S

Cartuccia anticalcare.
Antiscale cartridge.
Kartusche.

Art. _____

AC 03S



AC 10

Dispositivo anticalcare 2000 l/h.
Anti-limescale device 2000 l/h.
Kalkschutz-orrichtung 2000 l/h.

Art. _____

AC 10



1263

Colonna scarico in ottone, minimalista.
Brass drain column.

Art.

1263**1264**

Colonna scarico in plastica, minimalista.
Plastic drain column.

Art.

1264**1265 - OTTONE**

Colonna scarico in ottone, click clack.
Brass drain column.

Art.

1265**1266**

Colonna scarico in plastica, click clack.
Plastic drain column.

Art.

1266